

Full bridge
Series & parallel diodes
MOSFET Power Module

$V_{DSS} = 1000V$

$R_{DSon} = 450m\Omega$ typ @ $T_j = 25^\circ C$

$I_D = 18A$ @ $T_c = 25^\circ C$

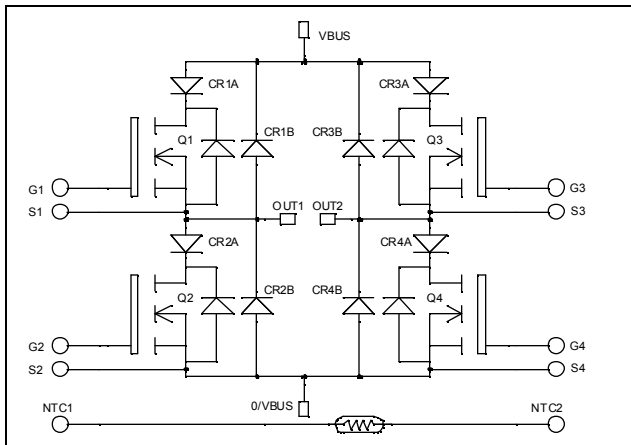

Application

- Motor control
- Switched Mode Power Supplies
- Uninterruptible Power Supplies

Features

- Power MOS 7[®] MOSFETs
 - Low R_{DSon}
 - Low input and Miller capacitance
 - Low gate charge
 - Avalanche energy rated
 - Very rugged
- Kelvin source for easy drive
- Very low stray inductance
 - Symmetrical design
 - Lead frames for power connections
- Internal thermistor for temperature monitoring
- High level of integration

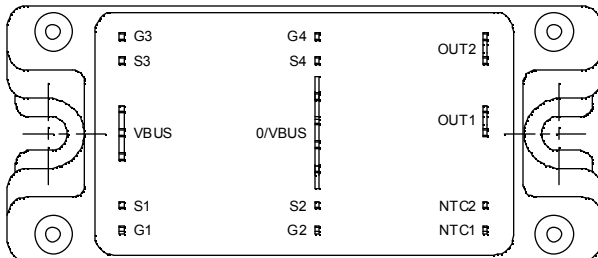

Benefits

- Outstanding performance at high frequency operation
- Direct mounting to heatsink (isolated package)
- Low junction to case thermal resistance
- Solderable terminals both for power and signal for easy PCB mounting
- Low profile
- RoHS Compliant

Absolute maximum ratings

Symbol	Parameter	Max ratings	Unit
V_{DSS}	Drain - Source Breakdown Voltage	1000	V
I_D	Continuous Drain Current	$T_c = 25^\circ C$	18
		$T_c = 80^\circ C$	14
I_{DM}	Pulsed Drain current	72	A
V_{GS}	Gate - Source Voltage	± 30	V
R_{DSon}	Drain - Source ON Resistance	540	m Ω
P_D	Maximum Power Dissipation	$T_c = 25^\circ C$	357
I_{AR}	Avalanche current (repetitive and non repetitive)	18	A
E_{AR}	Repetitive Avalanche Energy	50	mJ
E_{AS}	Single Pulse Avalanche Energy	2500	

CAUTION: These Devices are sensitive to Electrostatic Discharge. Proper Handling Procedures Should Be Followed. See application note APT0502 on www.microsemi.com

All ratings @ $T_j = 25^\circ\text{C}$ unless otherwise specified

Electrical Characteristics

Symbol	Characteristic	Test Conditions	Min	Typ	Max	Unit
I_{DSS}	Zero Gate Voltage Drain Current	$V_{GS} = 0\text{V}, V_{DS} = 1000\text{V}$			100	μA
		$V_{GS} = 0\text{V}, V_{DS} = 800\text{V}$			500	
$R_{DS(on)}$	Drain – Source on Resistance	$V_{GS} = 10\text{V}, I_D = 9\text{A}$		450	540	$\text{m}\Omega$
$V_{GS(th)}$	Gate Threshold Voltage	$V_{GS} = V_{DS}, I_D = 2.5\text{mA}$	3		5	V
I_{GSS}	Gate – Source Leakage Current	$V_{GS} = \pm 30\text{V}, V_{DS} = 0\text{V}$			± 100	nA

Dynamic Characteristics

Symbol	Characteristic	Test Conditions	Min	Typ	Max	Unit
C_{iss}	Input Capacitance	$V_{GS} = 0\text{V}$		4350		pF
C_{oss}	Output Capacitance	$V_{DS} = 25\text{V}$		715		
C_{rss}	Reverse Transfer Capacitance	$f = 1\text{MHz}$		120		
Q_g	Total gate Charge	$V_{GS} = 10\text{V}$		154		nC
Q_{gs}	Gate – Source Charge	$V_{Bus} = 500\text{V}$		26		
Q_{gd}	Gate – Drain Charge	$I_D = 18\text{A}$		97		
$T_{d(on)}$	Turn-on Delay Time	Inductive switching @ 125°C $V_{GS} = 15\text{V}$ $V_{Bus} = 667\text{V}$ $I_D = 18\text{A}$ $R_G = 5\Omega$		10		ns
T_r	Rise Time			12		
$T_{d(off)}$	Turn-off Delay Time			121		
T_f	Fall Time			35		
E_{on}	Turn-on Switching Energy	Inductive switching @ 25°C $V_{GS} = 15\text{V}, V_{Bus} = 667\text{V}$ $I_D = 18\text{A}, R_G = 5\Omega$		639		μJ
E_{off}	Turn-off Switching Energy			380		
E_{on}	Turn-on Switching Energy	Inductive switching @ 125°C $V_{GS} = 15\text{V}, V_{Bus} = 667\text{V}$ $I_D = 18\text{A}, R_G = 5\Omega$		1046		μJ
E_{off}	Turn-off Switching Energy			451		

Series diode ratings and characteristics

Symbol	Characteristic	Test Conditions	Min	Typ	Max	Unit
V_{RRM}	Maximum Peak Repetitive Reverse Voltage		200			V
I_{RM}	Maximum Reverse Leakage Current	$V_R = 200\text{V}$	$T_j = 25^\circ\text{C}$		250	μA
			$T_j = 125^\circ\text{C}$		500	
I_F	DC Forward Current			30		A
V_F	Diode Forward Voltage	$I_F = 30\text{A}$		1.1	1.15	V
		$I_F = 60\text{A}$		1.4		
		$I_F = 30\text{A}$	$T_j = 125^\circ\text{C}$		0.9	
t_{rr}	Reverse Recovery Time	$I_F = 30\text{A}$ $V_R = 133\text{V}$ $di/dt = 200\text{A}/\mu\text{s}$	$T_j = 25^\circ\text{C}$		24	ns
			$T_j = 125^\circ\text{C}$		48	
Q_{rr}	Reverse Recovery Charge	$I_F = 30\text{A}$ $V_R = 133\text{V}$ $di/dt = 200\text{A}/\mu\text{s}$	$T_j = 25^\circ\text{C}$		33	nC
			$T_j = 125^\circ\text{C}$		150	

Parallel diode ratings and characteristics

<i>Symbol</i>	<i>Characteristic</i>	<i>Test Conditions</i>		<i>Min</i>	<i>Typ</i>	<i>Max</i>	<i>Unit</i>
V _{RRM}	Maximum Peak Repetitive Reverse Voltage			1000			V
I _{RM}	Maximum Reverse Leakage Current	V _R =1000V	T _j = 25°C			250	μA
			T _j = 125°C			500	
I _F	DC Forward Current	T _c = 65°C			30		A
V _F	Diode Forward Voltage	I _F = 30A			1.9	2.3	V
		I _F = 60A			2.2		
		I _F = 30A	T _j = 125°C		1.7		
t _{rr}	Reverse Recovery Time	I _F = 30A V _R = 667V di/dt = 200A/μs	T _j = 25°C		290		ns
			T _j = 125°C		390		
Q _{rr}	Reverse Recovery Charge			T _j = 25°C		670	nC
				T _j = 125°C		2350	

Thermal and package characteristics

<i>Symbol</i>	<i>Characteristic</i>			<i>Min</i>	<i>Typ</i>	<i>Max</i>	<i>Unit</i>
R _{thJC}	Junction to Case Thermal Resistance	Transistor				0.35	°C/W
		Diode				1.2	
V _{ISOL}	RMS Isolation Voltage, any terminal to case t = 1 min, I _{isol} < 1mA, 50/60Hz			2500			V
T _J	Operating junction temperature range			-40		150	°C
T _{STG}	Storage Temperature Range			-40		125	
T _C	Operating Case Temperature			-40		100	
Torque	Mounting torque	To Heatsink	M5	2.5		4.7	N.m
Wt	Package Weight					160	g

Temperature sensor NTC (see application note APT0406 on www.microsemi.com for more information).

<i>Symbol</i>	<i>Characteristic</i>	<i>Min</i>	<i>Typ</i>	<i>Max</i>	<i>Unit</i>
R ₂₅	Resistance @ 25°C		50		kΩ
B _{25/85}	T ₂₅ = 298.15 K		3952		K

$$R_T = \frac{R_{25}}{\exp\left[B_{25/85}\left(\frac{1}{T_{25}} - \frac{1}{T}\right)\right]}$$

T: Thermistor temperature
R_T: Thermistor value at T

SP4 Package outline (dimensions in mm)

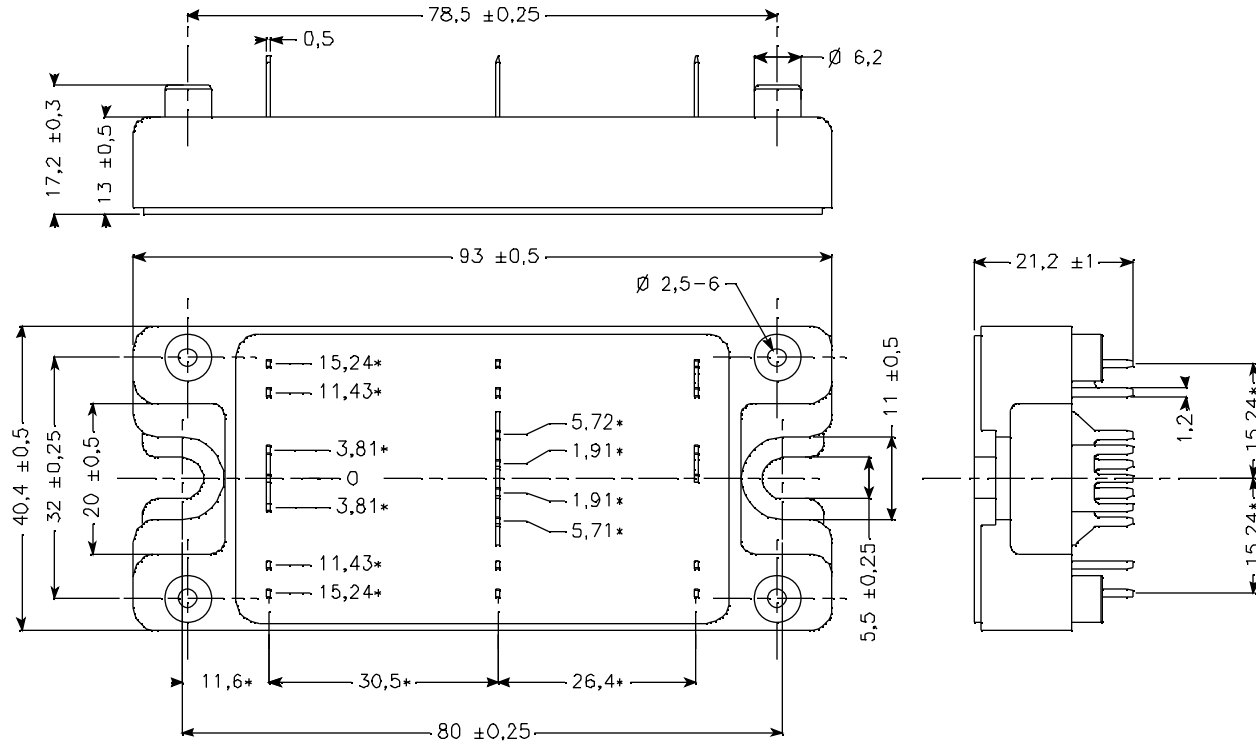

ALL DIMENSIONS MARKED "*" ARE TOLERANCED AS : $\varnothing 1$

See application note APT0501 - Mounting Instructions for SP4 Power Modules on www.microsemi.com

Typical Performance Curve

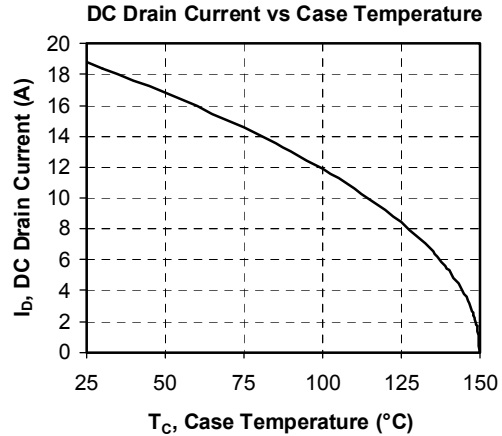
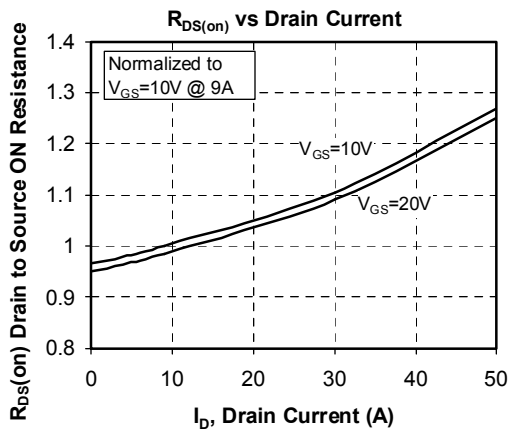
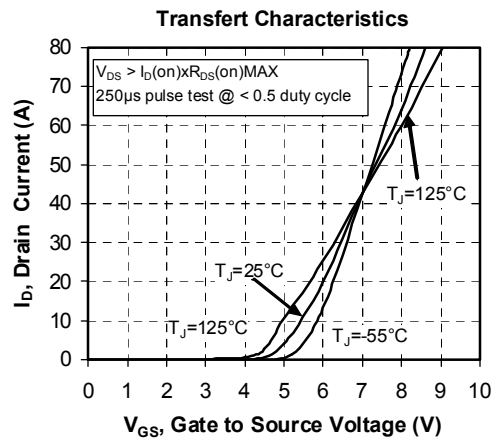
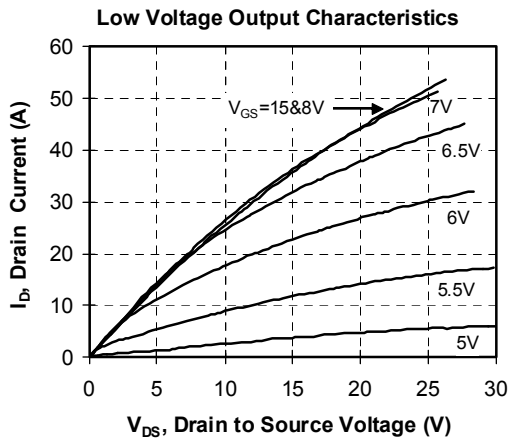
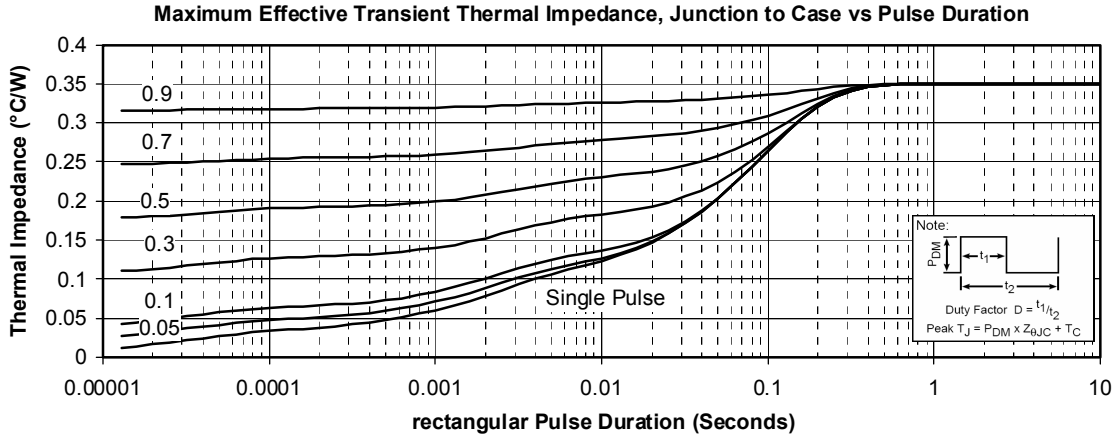

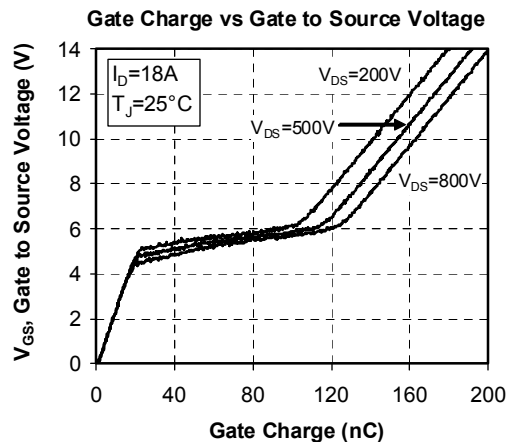
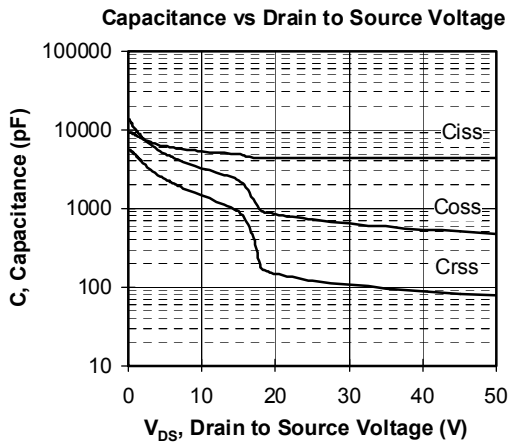
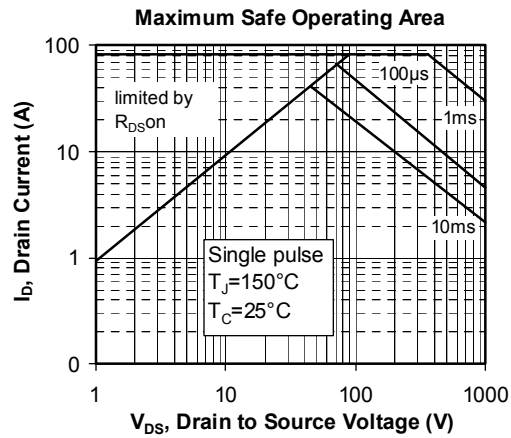
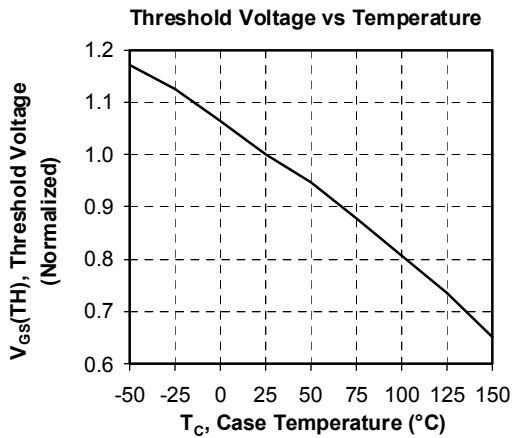
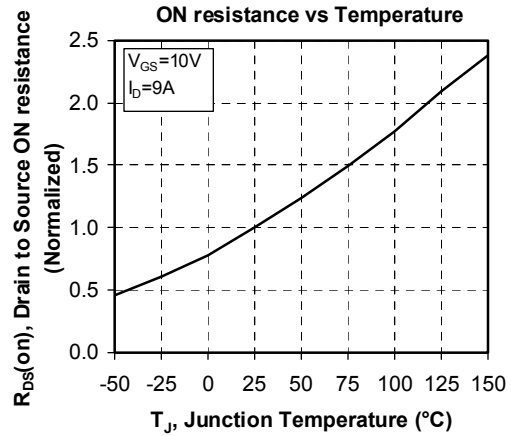
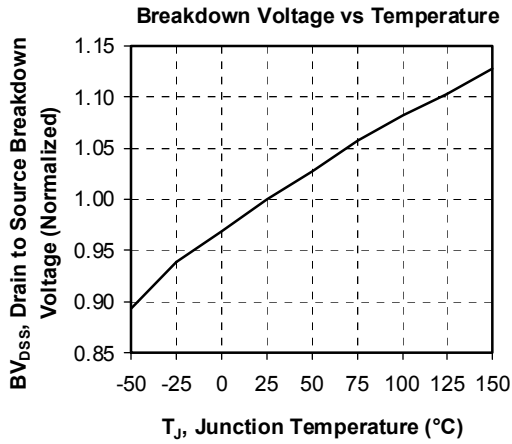

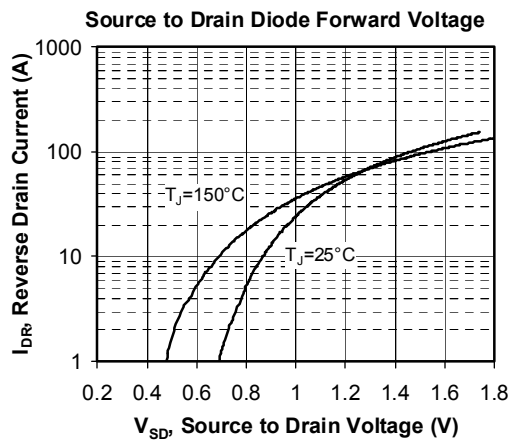
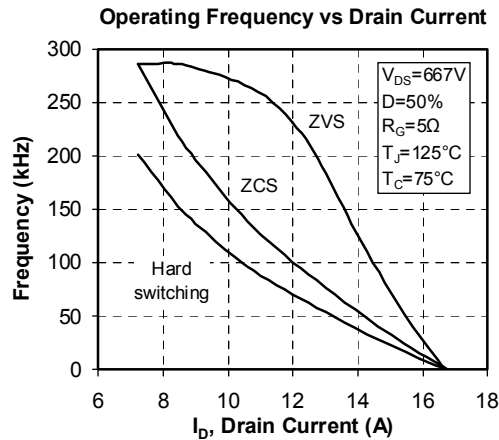
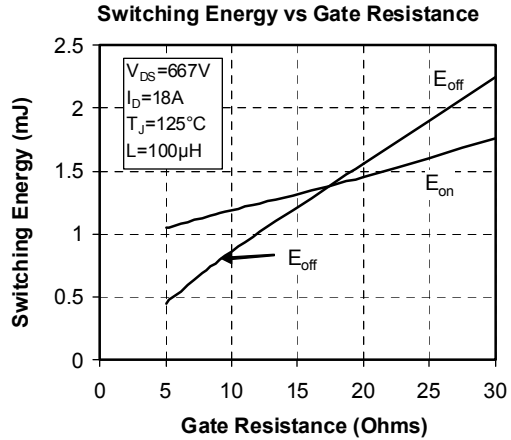
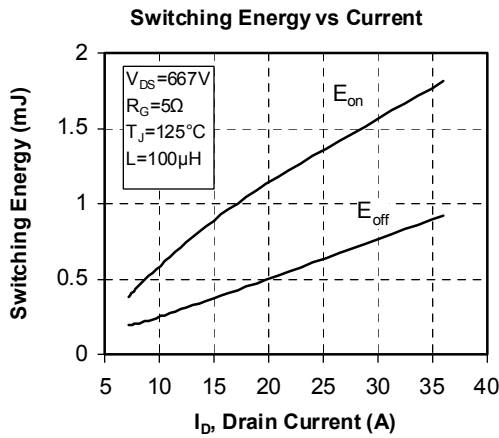
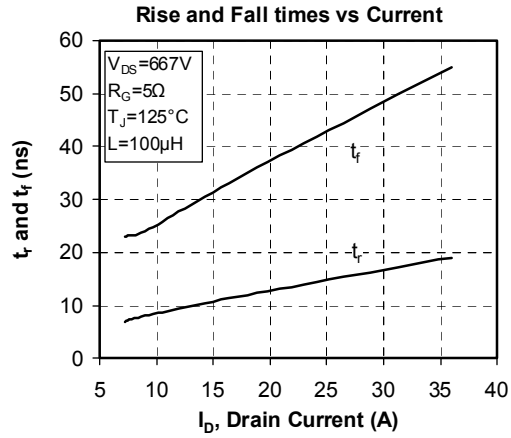
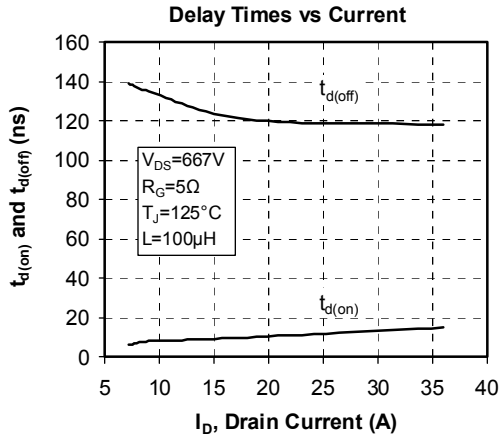

Microsemi reserves the right to change, without notice, the specifications and information contained herein

Microsemi's products are covered by one or more of U.S. patents 4,895,810 5,045,903 5,089,434 5,182,234 5,019,522 5,262,336 6,503,786 5,256,583 4,748,103 5,283,202 5,231,474 5,434,095 5,528,058 and foreign patents. U.S. and Foreign patents pending. All Rights Reserved.